

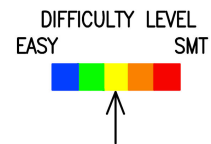

QRPCoder K8TND Patriot S.W. Regenerative Receiver



First, familiarize yourself with the parts and check for all the components. If a part is missing, please contact us at qrpbuilder@gmail.com and we will send you one. If you are new to parts identification refer to the appendix for part markings.

Please read all the instructions before starting to assemble the receiver.

Parts List

- 1 – QRPGuys K8TND Regen Receiver PCB, 4 pieces
- 1 – U1, LM386 DIP IC, wrapped with dip-8 socket
- 2 – Q1,2, J310 FET
- 1 – D1, green led
- 2 – D2,3 ISV149 varactor diode, marked v149
- 1 – D4, 1N4737A, 7.5V zener diode, small glass, black band on one end
- 1 – R1, 2K ohm resistor (red-black-red-gold)
- 1 – R2, 1 Meg ohm resistor (brown-black-green-gold)
- 2 – R4,11 5.6K resistor (green-blue-red-gold)
- 1 – R5, 150 ohm resistor (brown-green-brown-gold), see first note in appendix
- 1 – R6, 10 ohm resistor (brown-black-black-gold)
- 2 – R7,9, 10K resistor (brown-black-orange-gold)
- 1 – R8, 3.9 Meg ohm resistor (orange-white-green-gold)
- 1 – R10, 4.7K ohm (yellow-violet-red-gold)
- 2 – R3,12, 3.9K ohm (orange-white-red-gold)
- 1 – R13, 100K ohm resistor (brown-black-yellow-gold)
- 1 – R14, 2.7K ohm (red-violet-red-gold)
- 1 – C1, 220pF MLCC, marked 221, for less sensitivity substitute 68pF, marked 680
- 1 – C2, 33pF MLCC, marked 33
- 1 – C3, 820pF NP0/C0G marked 821
- 1 – C4, 100pF NP0/C0G capacitor, marked 101
- 3 – C5,9,17, .1uF MLCC marked 104
- 1 – C6, .001uF MLCC capacitor, marked 102
- 5 – C7,11,12,15,16, .01uF MMLC, marked 103
- 1 – C8, 470pF NP0/C0G capacitor marked 471
- 1 – C13, 10uF electrolytic capacitor
- 2 – C10,14, 100uF electrolytic capacitor

- 3 – VR2,3,4, 10K pcb horizontally mounted potentiometer
- 1 – VR1, 10K panel mount potentiometer
- 1 – VR5, 10K, vertically mounted potentiometer
- 2 – RFC1,2, 1.0mH molded inductor, green body, marked (brown-black-red-silver)
- 1 – J1, 3.5mm audio jack
- 1 – J2, BNC pcb female connector
- 1 – S1, SPDT slide switch
- 1 – 8 pin DIP socket, wrapped with LM386
- 1 – 9V battery clip-female
- 1 – 9V battery clip-male
- 1 – 48" 26awg red magnet wire
- 1 – 12" 26awg green magnet wire
- 1 – T1, T50-6 toroid core (yellow)
- 2 – 8-32 S.S. antenna wing nut assy.
- 2 – 4" cable tie
- 1 – 4" tinned copper wire
- 1 – heatsink compound softpak
- 4 – 3/8" dia. rubber foot
- 1 – 8" hook-up wire
- 1 – large control knob
- 3 – small control knob

Even if you have done radio kit assembly before, please read through all the instructions before you start. This kit is a little different, in that the mechanical chassis components are part of the printed circuit board. The instructions give you the scope of the project and an understanding of the techniques we have employed. You will be assembling the kit from four pieces of pcb material. The base pcb contains all the circuitry for the receiver. When you tack and then solder the remaining pcb components it will make a sturdy mechanical assembly. Refer to the appendix for identification of the individual pcb parts. You will be assembling all the electrical components on the Base pcb. When you have completed the chassis you will have a sturdy assembly.

There is much available information on the web for electronic kit building. Also, almost all amateur radio clubs have individuals that are most willing to aid beginners. Seek them out, if this is your first kit or you are unsure how to proceed.

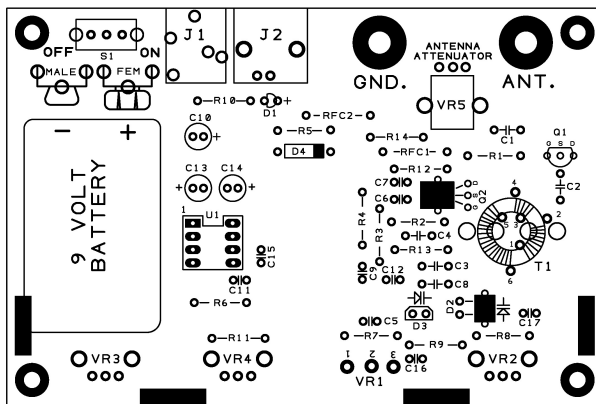

BASE

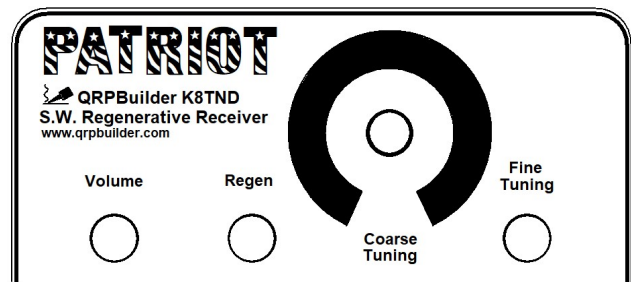

FRONT PANEL

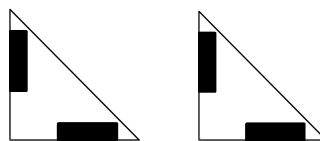

GUSSETS

Using the component placement graphic guide below, start assembling and check off as you go. On any component, I always solder a single lead first, align the component if needed, then solder the other pad(s). Clip the leads flush after installing each component or set of components.

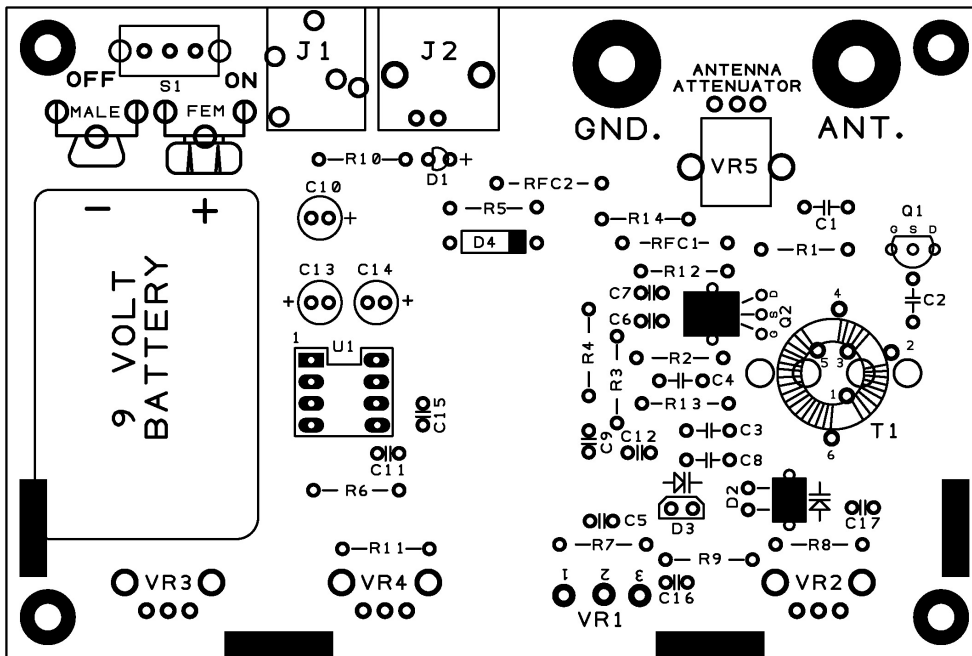

While the board is free of other components, the first thing to do is to install the two components that get tied down flush with the board. This helps in overall stability and drift from air currents. They are Q2 and D2. They both will mount with the part number face against the board with some thermal compound between the component and the board, secured with a short piece of the supplied wire. You will bend the component leads 90° towards the side with the part numbers as shown below, about 1/8" away from the body of the component.

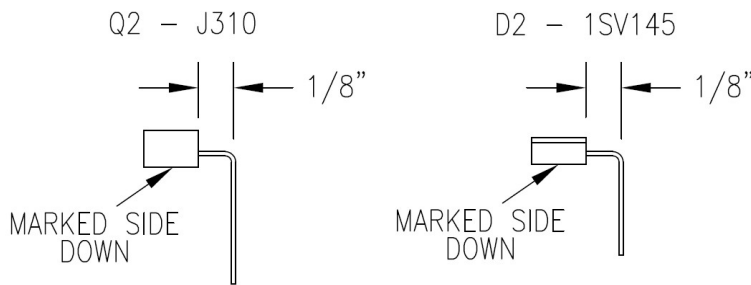

Do the Q2 and D2 one at a time

- [] Apply a **very small** daub of the supplied thermal compound onto the shiny rectangular tinned area at the component pad as shown below.

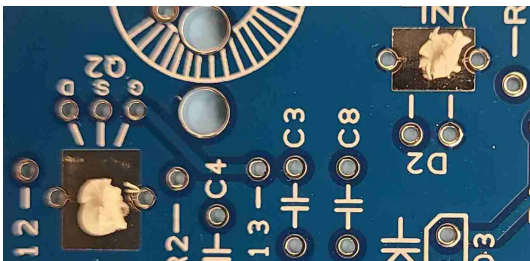

- [] Cut the 4" piece of tinned wire in half and make two loops. Insert the component, then Insert the ends of the loop into the two holes beside the rectangular pad, and secure the component flush on the board, by twisting the two ends on the bottom side, squeezing out the white compound as shown below.

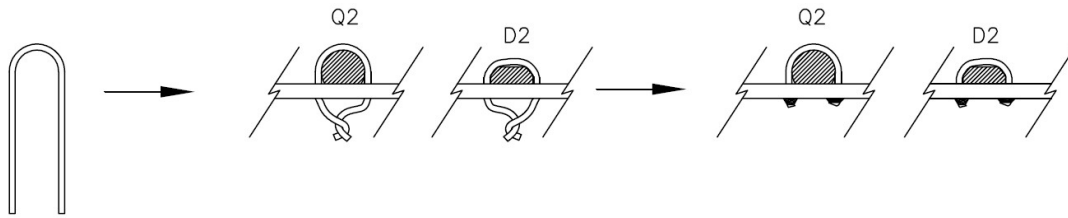

- [] Solder the wires where they pass through the pcb and trim off the twist.
- [] Solder the component leads for Q2 and D2, and trim.

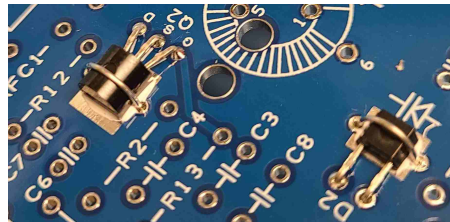

Shown finished

- [] Clean off any of the excess compound, taking care not to getting any of it in the other component holes.
- [] Install R1, 2K ohm resistor (red-black-red-gold)
- [] Install R2, 1 meg ohm resistor (brown-black-green-gold)
- [] Install R4,11, 5.6K resistor (green-blue-red-gold)
- [] Install R5, 150 ohm resistor (brown-green-brown--gold)
- [] Install R6, 10 ohm resistor (brown-black-black-gold)
- [] Install R7,9, 10K resistor (brown-black-orange-gold)
- [] Install R8, 3.9 Meg ohm resistor (orange-white-green-gold)
- [] Install R10, 4.7k ohm (yellow-violet-red-gold)
- [] Install R3,12, 3.9K ohm (orange-white-red-gold)
- [] Install R13, 100K ohm resistor (brown-black-yellow-gold)
- [] Install R14, 2.7K ohm (red-violet-red-gold)
- [] Install C1, 220pF MLCC, marked 221, for less sensitivity substitute 68pF, marked 680
- [] Install C2, 33pF MLCC, marked 33 or 330

- [] Install C3, 820pF NP0/C0G MLCC, marked 821
- [] Install C4, 100pF NP0/C0G capacitor, marked 101
- [] Install C5,9,17, .1uF MLCC, marked 104
- [] Install C6, .001uF MLCC capacitor, marked 102
- [] Install C7,11,12,15,16, .01uF, marked 103
- [] Install C8, 470pF NP0/C0G capacitor, marked 471
- [] Install RFC1,2, 1.0mH molded inductor, green body, marked (brown-black-red-silver)
- [] Install D4, 1N4737A, small glass diode, *match the band on the diode with the outline*
- [] Install D1, green led, *observe polarity, the long lead is positive*
- [] Install 8 pin DIP socket. Match the small notch with the board outline.
- [] Install D3, ISV149 varactor diode, marked v149
- [] Install Q1, J310 transistor, *match the board outline*
- [] Install J1, 3.5mm stereo jack
- [] Install S1, SPDT slide switch
- [] Install C10,14, 100uF electrolytic capacitor, *observe polarity, the long lead is positive*
- [] Install C13, 10uF electrolytic capacitor, *observe polarity, the long lead is positive*
- [] Install VR5, 10K, vertical potentiometer
- [] Install J2, BNC female connector
- [] Install the 9V battery clip-**female**, as shown below. **Don't mix them up.**
- [] Install the 9V battery clip-**male**, as shown below. **Don't mix them up.**

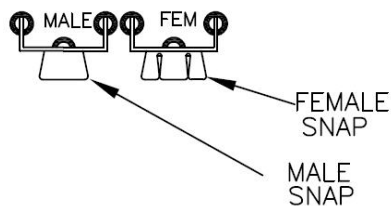

- [] Install VR2,3,4, 10K pcb horizontally mounted potentiometer

Winding the toroid

Note: Now is a good time to mention a good way for counting the turns on your toroids. Many times, if a small toroid has a lot of turns, you can lose track going around. A good trick is to take a digital picture of it **before** you trim the leads and enlarge it on your computer screen. Counting is clearly a lot easier.

We have supplied two colors of 26AWG wire to help you keep the windings separated.

- [] Cut a piece of the red 26AWG magnet wire 18" long. Start at the 5 o'clock position and wind CCW. Push 1" of the wire down the center hole of the toroid from the top and hold it, feed the remaining turns up from the bottom. **Every time the wire goes thru the center counts as one turn.** Wind a total of **12 turns**.
- [] Use the green 26AWG magnet wire. Start at the 2 o'clock position and wind CCW. Push 1" of the wire down the center hole of the toroid from the top and hold it, feed the remaining turns up from the bottom. **Every time the wire goes thru the center counts as one turn.** Wind a total of **8 turns**.
- [] Cut another piece of the red 26AWG magnet wire 24" long. Start at the 11 o'clock position and Wind CCW. Push 1" of the wire down the center hole of the toroid from the top and hold it, feed the remaining turns up from the bottom. **Every time the wire goes thru the center counts as one turn.** Wind a total of **19 turns**.

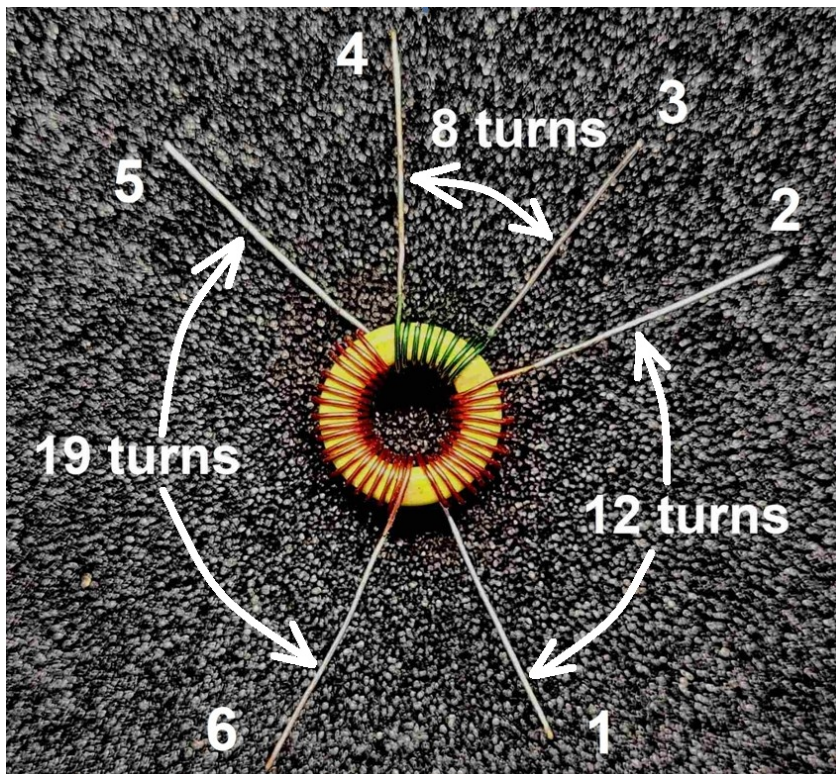

Your toroid should look like this if wound correctly and tinned, ready to bend the leads down.

- [] The magnet wire has Thermaleze enamel, and can be removed with a hot soldering iron. Tin the leads and scrape any of the remaining insulation residue from the tinning procedure. It should now look like the picture above

- [] When the leads are bent down, they will align with the six pcb pads shown in the graphic below.

Tip: If all the leads are exactly the same length, it is difficult to align all six leads simultaneously. Cut them slightly different lengths and you can align and insert them easily. Just start with the longest one first.

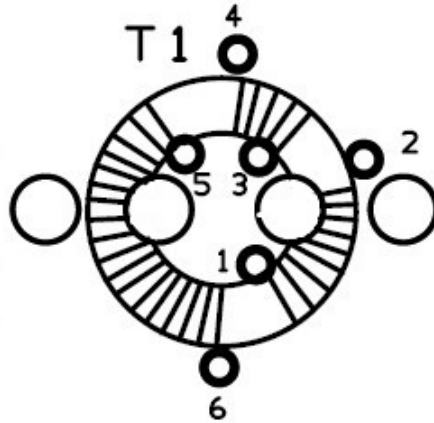

- [] Install T1 flush with lead numbers in the correct holes, and solder the six leads. Note below.

Faulty toroid soldering is a common fault area for kit builders. We always tell you to tin the wires before installing and when installing the toroid, do not pull the lead past where you have it tinned on the back of the board. Attention to detail here will ensure a successful outcome.

Carefully inspect the toroid soldering and installation

- [] Secure the toroid to the pcb with the two nylon cable ties, as shown below.

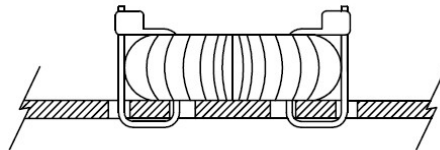

- [] Install the 8-32 SS antenna wingnut assembly at the antenna and ground connection position as shown in the graphic below. If done this way, you will never lose the wingnut.

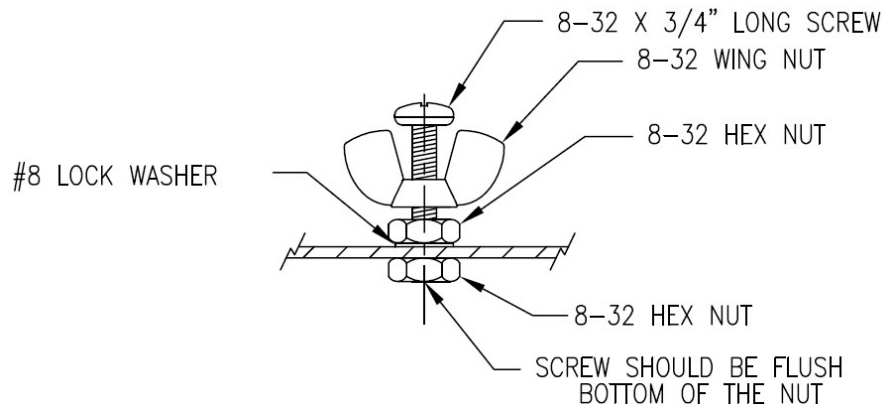

PCB Chassis assembly

On all the mechanical assembly soldering of the pcb's, you will use the same technique. You tack (solder) a single tiny point first, and then check to see that it is square and aligned properly with the assembly notes. Take your time and make sure everything is aligned. It is easy to re-heat the joint and adjust the alignment when there is only a single point. You will tack all the other pads, before you do the finish soldering. After finished soldering of the chassis, the assembly will be remarkably strong.

If you don't understand the instructions before you start to solder, please ask for clarification.

Now you are going to solder the four pcb pieces that form the chassis.

- [] Apply a **small** amount of solder to the all the 12 pads prior to positioning them as shown below.

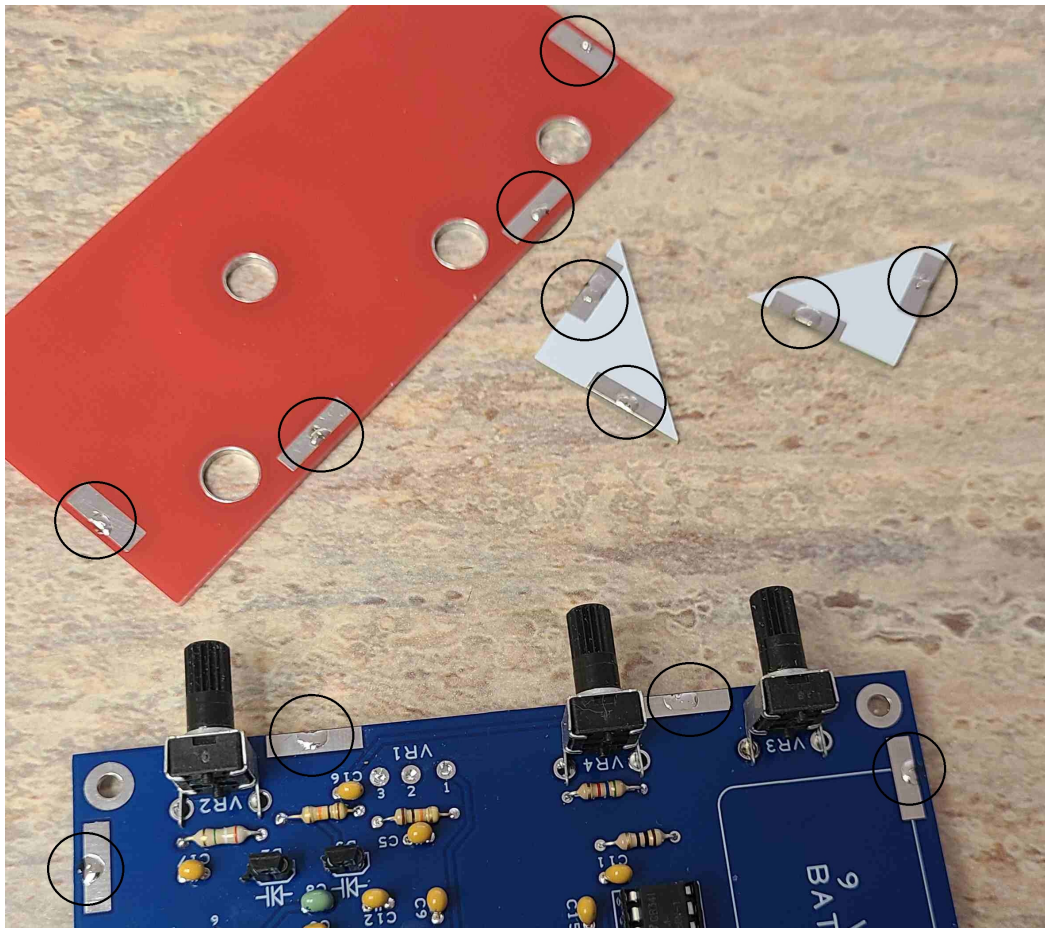

- [] Tack the two Gussets to the Base. When finished, you want them to be 90° as shown below, flush with the front edge of the Base pcb and flush with the sides. To check the 90°, cut the corner off a piece of printer paper or 3x5 card and use it as a gage on the inside of the boards. If the side needs adjustment, just reheat the small joint and reposition. **Do not try to bend the gusset without reheating, or you pull the copper off the pcb.** You will go back and finish soldering after the front panel is attached. Refer to the graphics below.

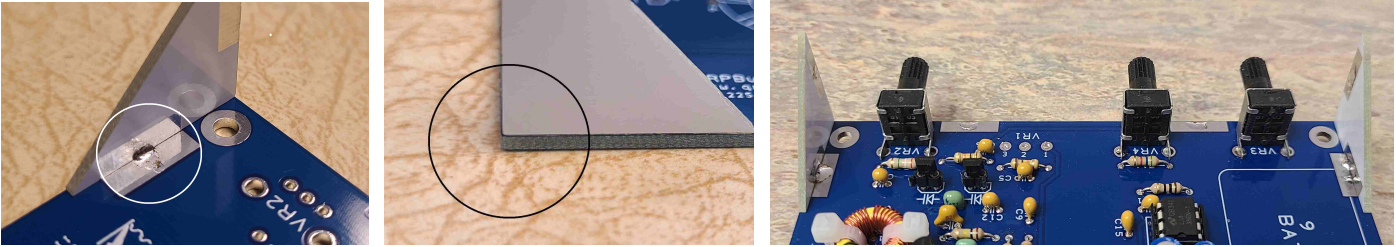

Small tack

Flush on front and sides

Both sides 90°, ready for next step

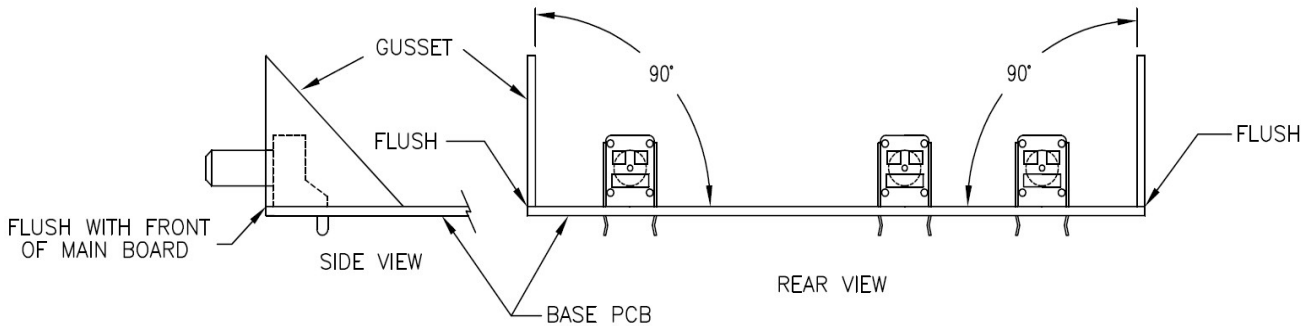

- [] A flat surface is needed for the next step. If a kitchen counter is used, obtain permission first.
- [] Place the board on top of two pencils, as shown, so that the pencils are not touching any of the protruding component leads, and tape the pencils to the work surface. Then tape the board to the work surface as well to keep it in place when attaching the front panel. Leave room at the front end of the board with the pots, with bare pencil diameter surface exposed.

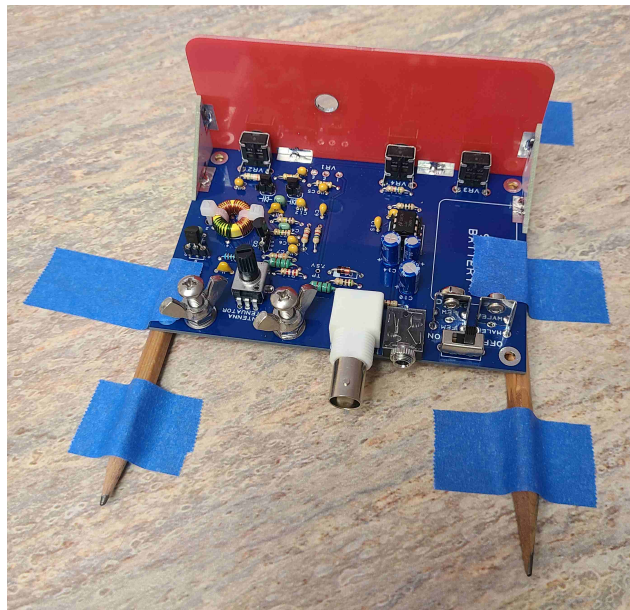

- [] Position the Front Panel flush with the top of the pencils, against the front surface of the Base pcb and gussets. When you have centered the Front Panel flush with both sides, melt one of the small tack you previously applied to the base with the Front Panel as shown below. Then do the other.

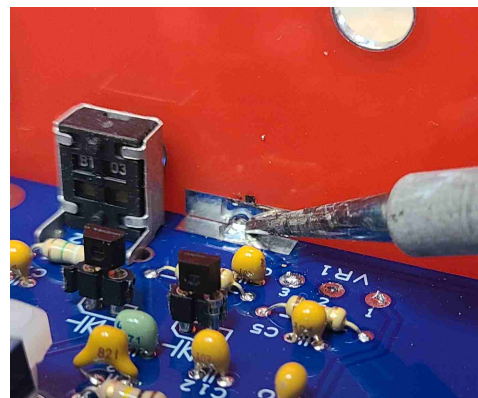
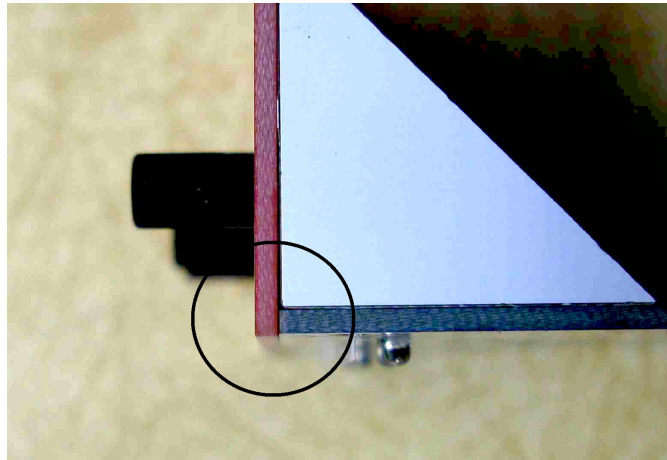

- [] Next, tack the two gussets to the Front Panel on each side.

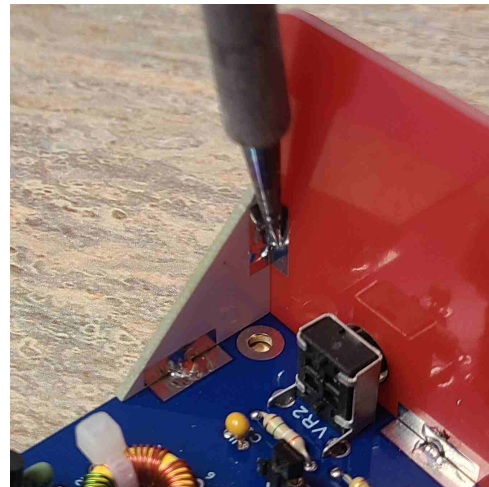
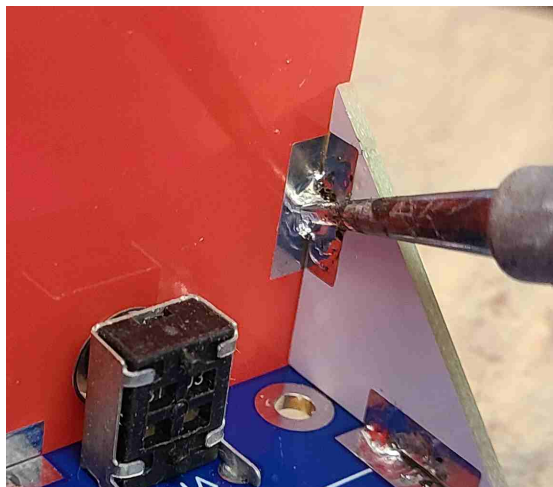

- [] Take a minute to inspect the position of all the pcb pieces to see if you have met all the requirements shown below. It is easy to re-heat a small tack and re-position. *When you are satisfied and all the alignments are met, you may now go back and complete the soldering of all of the pads.*

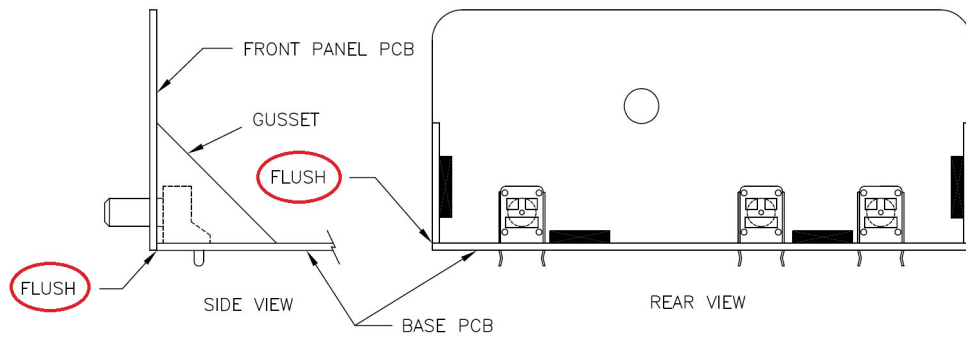

Completed chassis assembly

- [] Attach the 4 rubber feet to the bottom corners of base pcb where indicated.

- [] Mount VR1 to the front panel with the nut that came with the pot. Use three 2 1/2" long pieces of the hook-up wire supplied to connect the potentiometer to the pcb matching the number sequence in the graphic with the numbers on the pcb.

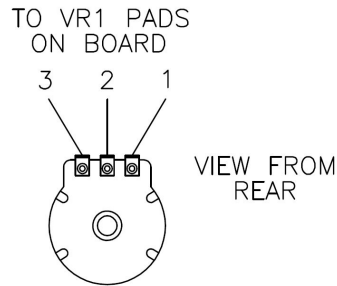

- [] Install the large control knob on the Main Tuning potentiometer shaft. Every large knob is inspected 100% for the presence of the brass set screw, and then taped to prevent it's escape. Remove the tape carefully and check it has not dislodged in transit. It is metric, and may be difficult to locate locally if you lose it..
- [] Install the three small white knobs on the board mounted potentiometers. Support the back of the pots when pushing on the knobs. They take a little force, and you do not want to damage potentiometers.
- [] Install a fresh 9V alkaline battery. Turn on S1 to power up the receiver. The green led should illuminate and check for +9.V at pin 6 of the U1 socket. If all is ok, turn off the power switch and install U1 - LM386 into the U1 socket noting the position of pin 1 shown in the graphic below.

The pins are flared on new IC's, so that they can be retained by automatic insertion tools. Carefully and gently rock it on a flat surface so the pins are parallel and it will insert into the socket more easily reducing the risk of breaking or bending a pin.

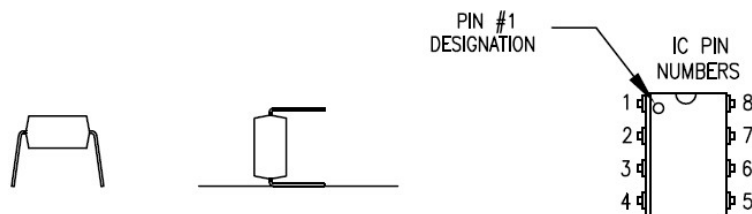

This completes the assembly.

Testing with an antenna and alignment:

It is easiest to mark the approximate locations of the SWL bands, WWV, etc. by using another receiver. Loosely couple the antenna with that of a nearby receiver and it will pick up the local oscillator in your regen receiver. Note the frequency or band of interest and mark with a pencil on the front panel. Make sure your fine tuning pot is in the middle of its range and you will have fine tuning either side of the frequency or band you marked. The "Fine Tuning" will cover a range of about 15-20KHz. The overall bandsread is about 5.1MHz to 15.1MHz.

General tips and operation using a Regenerative receiver:

AM stations are best heard with the Regen control to the counterclockwise side of the knob travel, and then advanced clockwise just before sidetones are heard. **CW/SSB** stations are best heard with the Regen control to the clockwise side of the knob travel, as they require the sidetones to be present. The Regen and both Tuning controls interact with each other so a little tweaking is required. The Antenna Attenuator potentiometer, VR5 will help with a very strong signal overloading the first stage. Turn CCW to decrease signal strength, and CW to increase.

The main tuning is very sharp. We are squeezing 10MHz of bandsread from (~5MHz to 15MHz) into a single turn pot. We wanted to include the 20m amateur band. The fine tuning control (15-20KHz) will give you the ability to center the stations once you get close with the main tuning control. When changing frequency by any appreciable amount, it will be necessary to re-adjust the "Regen" control for maximum signal strength. Adjustment may also be necessary if the "Regen" starts to oscillate. Use the minimum amount of volume for comfortable listening. With a regenerative receiver a little back and forth is necessary, and you will get the hang of it after a few tries.

Once a battery falls below 7.5 volts it should be replaced.

Other great tips on regenerative receiver tuning can be found here at the ARRL site, <http://www.arrl.org/tuning-a-regenerative-receiver>.

Additional option notes:

This is not a necessary step. After a few minutes of warm up, any drift is caused by air currents affecting the temperature of various components. We have tied down Q2 and D2 to the pcb and used NP0/C0G capacitors in the critical areas for this reason. If you want to further mitigate drift, we have found that a daub of 100% silicone encasing C3, Q2, and D2 as shown in the picture below can be helpful as well. This isolates the body of these components even more from air currents.

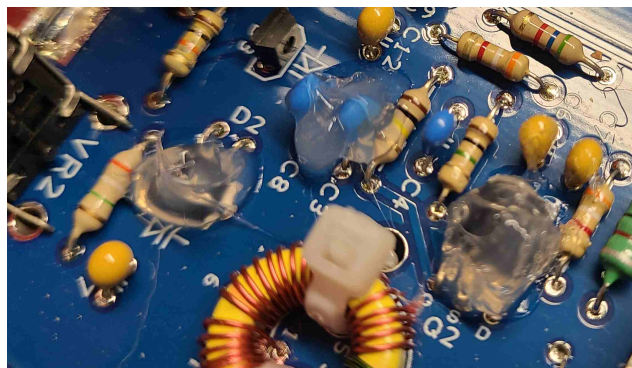

Depending on your antenna capabilities, you may want to decrease the overall sensitivity. You can replace the 220pF capacitor (C1) with the 68pF capacitor for less sensitivity.

Appendix:

- Kits shipped before 4/27/26 will have a 51ohm resistor for R5. After 4/27/26 there is a 150ohm resistor for improved battery life.
- All the resistors are 4 color, 5% tolerance, 1/4 watt, carbon type, tan body colored so the colors are easy to identify.
- Ceramic disk, multi-layer ceramic capacitors (MLCC), and C0G/NP0 capacitors are all clearly marked, although some may quite small and may need magnification. Tolerance code may be omitted. *The blue colored ones have dark markings and are difficult to read without magnification.*
- Electrolytic capacitors are polarized, clearly marked, and for this kit, can be 16V, 25V, or 50V.
- Molded inductor bodies are green and identified by the chart below.
- Some of the integrated circuits, diodes and transistor markings may be quite small and require some magnification.

Resistor Color Codes

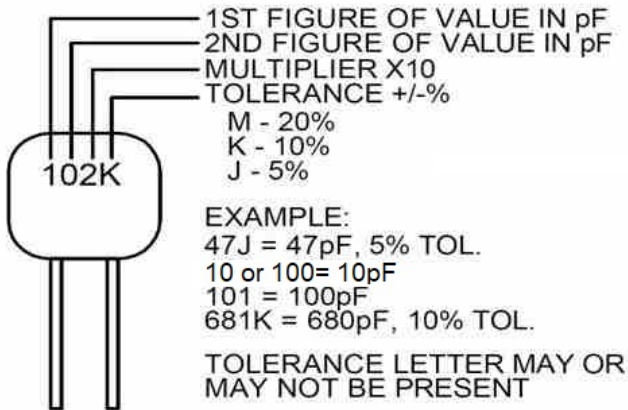

| | Value | Multiplier |
|--------|-------|------------|
| Black | 0 | 1 |
| Brown | 1 | 10 |
| Red | 2 | 100 |
| Orange | 3 | 1k |
| Yellow | 4 | 10k |
| Green | 5 | 100k |
| Blue | 6 | 1M |
| Violet | 7 | 10M |
| Grey | 8 | |
| White | 9 | |

| | Tolerance |
|--------|-----------|
| Silver | 10% |
| Gold | 5% |
| Red | 2% |
| Brown | 1% |

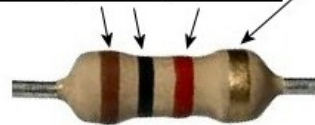

1 0 2 = 10*100 = 1k Ohm

Ceramic capacitor markings

Note: When reading the mono capacitor values, do not confuse the manufacturing codes with the component value. If it looks strange, it may be a manufacturing code, look on the other side of the component. Also the tolerance letter may be omitted.

INDUCTOR COLOR GUIDE



| COLOR | 1st BAND | 2nd BAND | MULTIPLIER | TOLERANCE |
|--------|----------|----------|---------------------|----------------|
| BLACK | 0 | 0 | 1 | ± 20% |
| BROWN | 1 | 1 | 10 | Military ± 1% |
| RED | 2 | 2 | 100 | Military ± 2% |
| ORANGE | 3 | 3 | 1,000 | Military ± 3% |
| YELLOW | 4 | 4 | 10,000 | Military ± 4% |
| GREEN | 5 | 5 | | |
| BLUE | 6 | 6 | | |
| VIOLET | 7 | 7 | | |
| GREY | 8 | 8 | | |
| WHITE | 9 | 9 | | |
| NONE | | | | Military ± 20% |
| GOLD | | | 0.1 / Mil. Dec. Pt. | Both ± 5% |
| SILVER | | | 0.01 | Both ± 10% |

Troubleshooting notes:

It is best to have another set of eyes look at the kit if at all possible. Sometimes you can pass over an obvious error.

- As with all kits, soldering is the number 1 issue. Check with a magnifying glass every single joint for solder flow around the lead.
- Number 2, less seen is the wrong component or two components swapped. Carefully recheck that the components are in the correct position.
- Next area of concern is the toroid winding, wires in the correct numbered hole and the tinning/soldering of the leads.

If you have satisfied/corrected all the above, proceed to the specific items below.

1. Receiver has no signals, squeals toward one end of the main tuning range:

Check wiring from PCB to VR1.

2. No audio or audio intermittent:

Check for pin1 orientation of the LM386, and reseal LM386, check and re-solder audio jack connections.

3. No Light from LED.

Check battery clip solder connections, re-solder same.

4. No signals but hear hiss in headphones.

Check to see if regen control is making a slight plop sound and background static increases at a point somewhere along the controls turning range.

Check on another receiver to see if you can hear the oscillator from the Patriot. If you have a signal generator, put it on maximum output and see if you can hear it when you sweep the Patriot's bandsread.

Check all the solder connections on the PCB that are directly related to Q2 which is the oscillator/detector transistor. Go over the connections with a strong magnifier to look for an open solder connection.

5. Most regen receivers will drift with varying temperatures. This design has construction practices and component selection to alleviate much of this drift.

Extreme amounts of drift:

Use a fresh battery. Check the battery Voltage with the receiver turned on. It should be at least 7.5 volts, if not, replace battery.

Check to make sure there are no fans or drafts blowing on the PCB. If so, you can mitigate the drifting by placing a soft, clean, light cloth over the circuit board to keep the drafts off. This will help some, and the silicone coating to reduce the temperature change on specific components, mentioned earlier on page 13.